

TATA STEEL

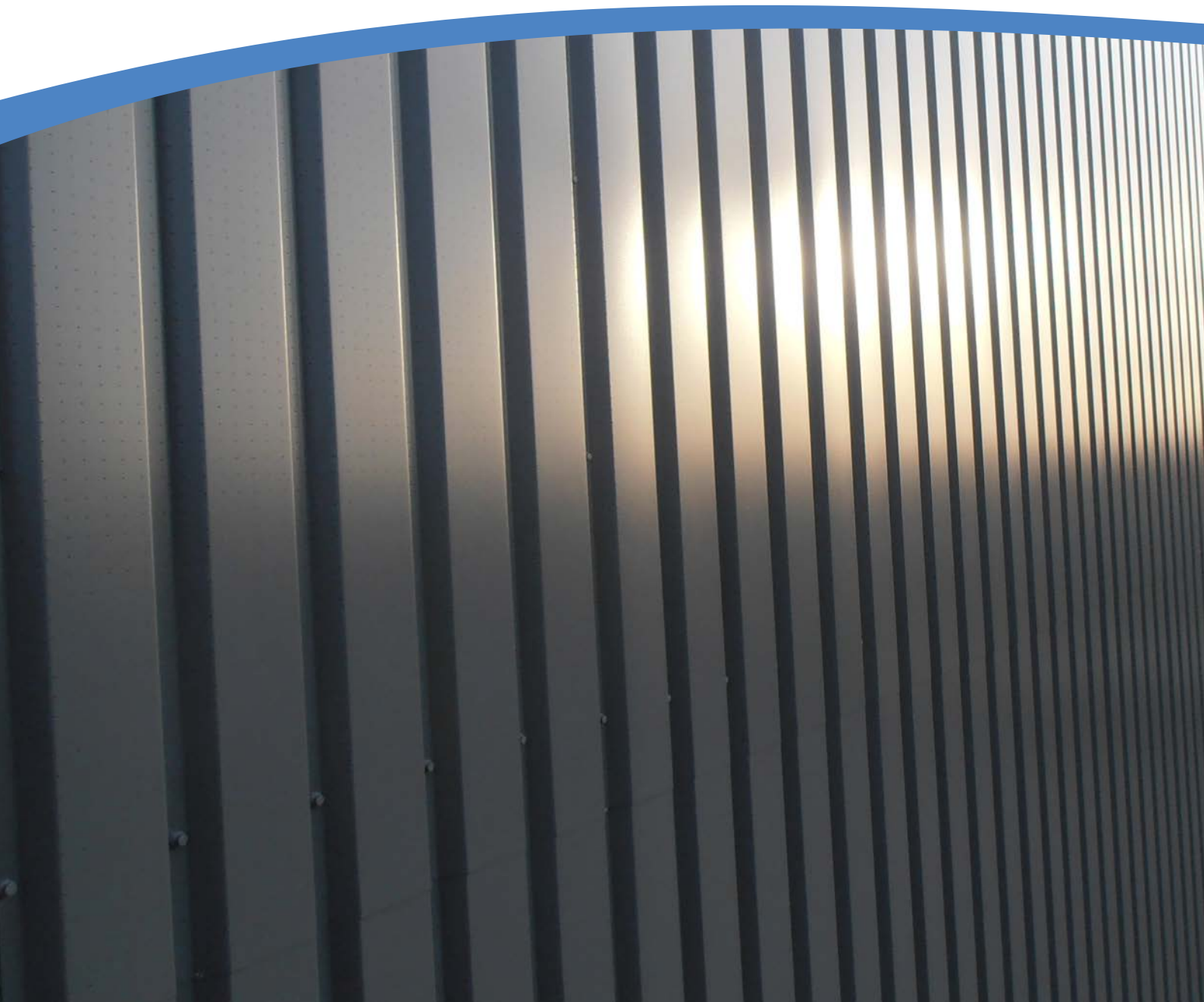

Colorcoat Renew SC[®]

Design guide





Contents

1. Colorcoat Renew SC® system overview	4	3.4 Other physical solar collector design considerations	15
1.1 Introduction	4	3.4.1 Perforation diameter and pitch	15
1.2 Working principles of Colorcoat Renew SC®	4	3.4.2 Profile options	16
1.3 Benefits of a Colorcoat Renew SC® system	5	3.4.3 Cavity (plenum)	16
1.4 Colorcoat Renew SC® integration	6	3.4.4 Solar collector integration	17
1.4.1 Suitable building types	6	4. Construction	17
2. System performance factors	7	4.1 Requirements and regulations	17
2.1 General design factors	7	4.2 Collector components	17
2.1.1 Solar collector orientation	7	4.3 Typical construction details	18
2.1.2 Collector angle (Tilt)	8	4.4 Fasteners	21
2.1.3 Shading	8	4.5 Maintenance recommendations	21
2.2 Colour selection and influence on performance	9	5. Mechanical and electrical design considerations	22
2.2.1 Guarantee Colorcoat Renew SC®	10	5.1 Building heating and ventilation requirements	22
3. Collector design and sizing	11	5.1.1 Intake air quality	22
3.1 Building geometry, occupancy and function	11	5.2 Relationship between airflow, temperature increase and efficiency	23
3.2 Solar collector sizing - description	12	5.2.1 Temperature rise	23
3.2.1 Choosing the wall		5.2.2 Wind considerations	24
3.2.2 Determining the volume of the building space to be heated		5.2.3 Transition duct sizing	24
3.2.3 Determining the volume of air required by the building ventilation system		5.2.4 Pressure drop	24
3.2.4 Determining the optimum balance of heating and ventilation requirement		5.3 Operating modes	25
3.2.5 Collector sizing guidelines		5.4 System control and metering	25
3.3 CRAFT (Colorcoat Renew SC® Assessment and Feasibility Tool)	14	6. Reference projects	26
3.3.1 Feasibility	14	7. Colorcoat Renew SC® - product characteristics	27
		8. References/Bibliography	28
		9. Additional services and contact points	28

1. Colorcoat Renew SC® system overview

1.1 Introduction

This guide describes Colorcoat Renew SC®, how it works and how this solar air heating solution can be integrated into a building. The focus is to assist construction professionals and their clients to understand the potential benefits of Colorcoat Renew SC® and how to successfully incorporate the system into

a building design. The system has been independently and successfully tested in accordance with EN 12975-2006 and ISO 9806: 2013 and provides an efficient and cost-effective system giving reliable performance and durable construction.

1.2 Working principles of Colorcoat Renew SC®

Colorcoat Renew SC® is an active solar air heating system consisting of a micro-perforated, pre-finished steel solar collector installed as an additional external skin on a structurally sound wall, and sealed at the perimeter. The collector creates a cavity or plenum with the supporting wall and a penetration is made through the supporting wall substructure to allow installation of ductwork to transfer the heated air from the cavity into the building interior. A fan unit integrated in the building space or within the air handling unit is used to create negative pressure within the transfer cavity. The pre-finished steel solar collector absorbs solar radiation and develops a boundary layer of solar heated air on the surface of the micro-perforated collector. The heated air layer is then drawn through the perforations into the cavity and subsequently into the building space.

Colorcoat Renew SC® provides solar heated air for ventilation and space heating of buildings. The most suitable buildings for this system are non-domestic buildings in the industrial, commercial and public sectors. The actual performance of the system is subject to individual building design and layout, ventilation and heating requirements. The technology can also be used for the supply of process heat, but this demands a separate approach. For more information contact the Colorcoat Renew SC® Integrated Sales Team on T: +44 (0) 1244 892336 or 892331.

Data from completed building projects in Northern Europe has proven that Colorcoat Renew SC® can typically supply 30-40% of daytime heating energy demand. The system depends on the availability of solar radiation as its functional source, Colorcoat Renew SC® must be regarded as a

supplementary heat source, the purpose of which is to reduce energy demand on, and therefore improve the efficiency of, conventional heating systems.

Colorcoat Renew SC® meets the criteria of the European Renewable Energy Directive (2009/28/EC) to allow classification by the European Commission as a renewable energy generating source. It will therefore provide significant, sustainable environmental benefits to a building by reducing fossil fuel energy consumption, which can in turn help towards meeting local and governmental compliance requirements for building energy efficiency and decarbonisation as defined by EU 2020 targets. It will also help to achieve credits in energy and materials categories of environmental assessment schemes such as BREEAM or LEED.

Colorcoat Prisma® pre-finished steel from Tata Steel is used for the solar collector to provide a combination of excellent durability and superior solar-thermal absorption capability, and in order to maximise collector performance and longevity and to provide a truly sustainable solution.

The focus of this guide is the use of Colorcoat Renew SC® to provide pre heated make-up air to an integrated gas heating/air handling system using a proven, transpired solar collector construction methodology. An alternative configuration, suited to the provision of solar heated air, in parallel to a main heating unit is also available. For more information contact the Colorcoat Renew SC® Integrated Sales Team on T: +44 (0) 1244 892336 or 892331.



1.3 Benefits of a Colorcoat Renew SC® system

- Reduces fuel bills.
- Fresh heating and ventilation air.
- Renewable solar energy.
- Easily integrated into building envelope.
- Low cost, low maintenance.
- Uses standard industry components.

Colorcoat Renew SC® provides fresh, warm air for mechanical ventilation and space heating of buildings. Taking advantage of natural, freely available solar radiation to pre heat the fresh air-feed to a warm air space heating system, Colorcoat Renew SC® is one of the most sustainable, readily available renewable energy choices for the building designer.

By supplying renewable, pre heated air to the air handling unit rather than low ambient temperature air, less fuel is needed to heat the external air supply to meet building set point temperatures. As a result, savings can be made in overall building heating energy costs.

Through the use of straightforward system and damper control mechanisms, the airflow and temperature can be regulated to provide both ventilation and heating strategies.

As it uses standard metal building envelope components to provide a supplementary source of heat to complement conventional heating and ventilation (HVAC) equipment, the low incremental capital cost of Colorcoat Renew SC® is quickly repaid through savings in use of gas or other fuels, resulting in favourable returns on investment for the building occupier.

The Colorcoat Renew SC® system can easily be integrated in the building envelope, requires little maintenance and uses standard industry components. The use of Colorcoat Prisma® for the micro-perforated solar collector facilitates a high conversion of available solar energy to heated air (up to 75%). This results in a high instantaneous energy yield easily reaching up to 600 W/m² of collector area at peak times.

As daytime heating is normally only required during certain months of the year, the Colorcoat Renew SC® system typically yields on average 200-250 W/m² per annum in Northern Europe.

Even on cold winter day's temperature uplifts of 15 to 25°C can be delivered over the ambient external air temperature thus reducing the amount of fuel otherwise needed to heat the air to meet the building set point. Indeed if the building set point temperatures are in the region of 16 to 18°C, the Colorcoat Renew SC® system may often provide the entire heat requirement for the building during daytime operation. To accommodate periods when Colorcoat Renew SC® cavity air temperatures are higher than building set points, for example during summer months, or even at certain times during the daytime heating season an alternate fresh air feed is utilised to provide ambient ventilation air. See section 5.

Figure 1. Colorcoat Renew SC® - Construction and operating principles

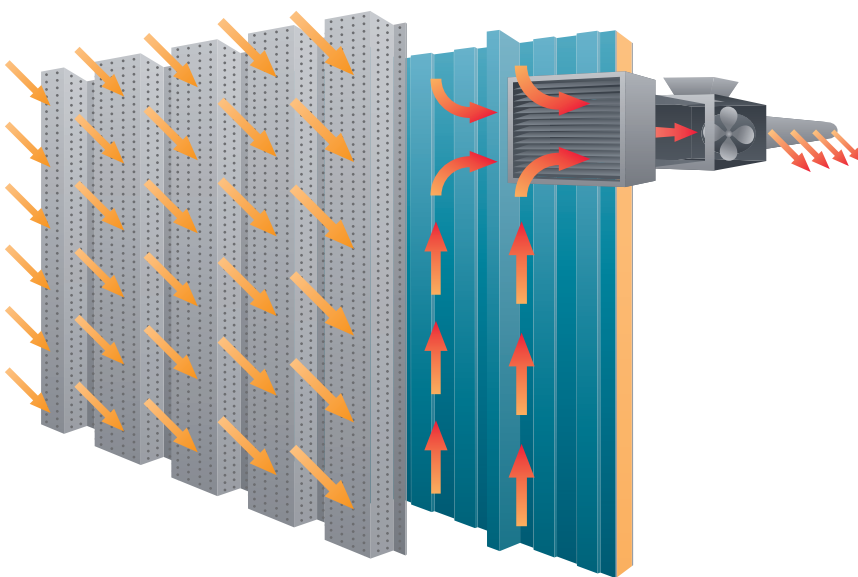

Case study

Deeside Leisure Centre, Queensferry,
Flintshire

Deeside Leisure Centre building envelope was transformed using Tata Steel's Colorcoat® products.

Installation of the Colorcoat Renew SC® solar air heating system was a vital part of the solution to provide renewable energy to reduce operating costs and the centre's carbon footprint.

Client: Flintshire County Council

Installation contractors: Lester Fabrications (wall)
Kimpton Building Systems (M&E)

Tata Steel products: Colorcoat Renew SC® solar air heating system with micro-perforated Trisobuild® C32 profile solar collector. Installed vertically over existing Trisobuild® C32 wall profile.



1.4 Colorcoat Renew SC® integration

The most straightforward and cost-effective integration of Colorcoat Renew SC® is to install the solar collector as a pre heater, using the fan of an integrated HVAC air-handling unit to draw the warmed air through the cavity into the HVAC system.

1.4.1 Suitable building types

Suitable buildings have open, unrestricted internal spaces, for which heating of air is the most efficient and economic medium for occupant comfort, and which benefit from medium to high mechanical air-change or ventilation rates. Suitable building types include factories, workshops, showrooms, offices, schools, hospitals and leisure centres.

Alternative configurations for installing Colorcoat Renew SC® independently of existing heating systems may also be appropriate – Please contact the Colorcoat Renew® Design Team directly for further information on T: +44 (0) 1244 892336 or 892331.

2.1.2 Collector angle (Tilt)

To maximise solar radiation benefit during the heating season, wall collectors are recommended and are the most practical and cost-effective to install. A vertical wall is more efficient whilst the sun is lowest in the sky during the winter months, a period when heating demand is likely to be at the maximum.

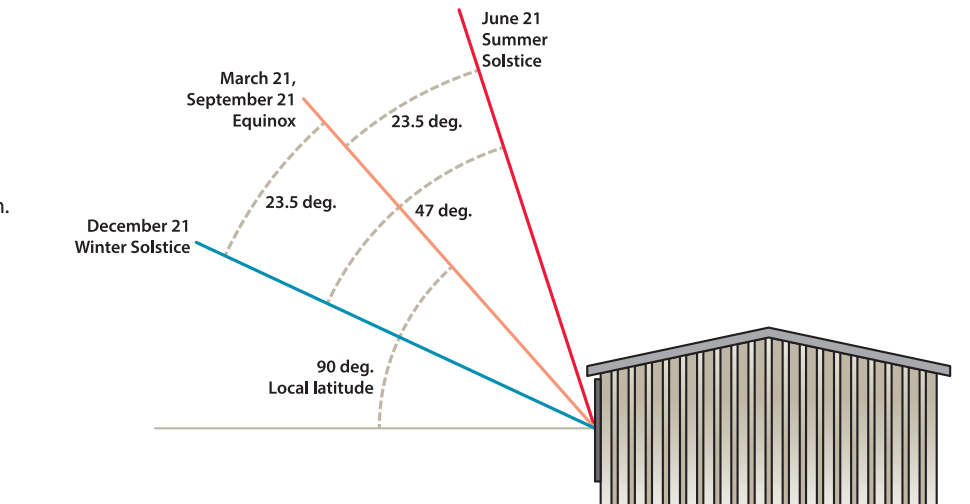

2.1.3 Shading

Shading of the Colorcoat Renew SC® system should be avoided. When carrying out a feasibility study or site visit, potential shading from elements such as trees, pylons, chimneys, stacks, surrounding buildings and other landscaping features should be noted and their impact considered early in the system design process.

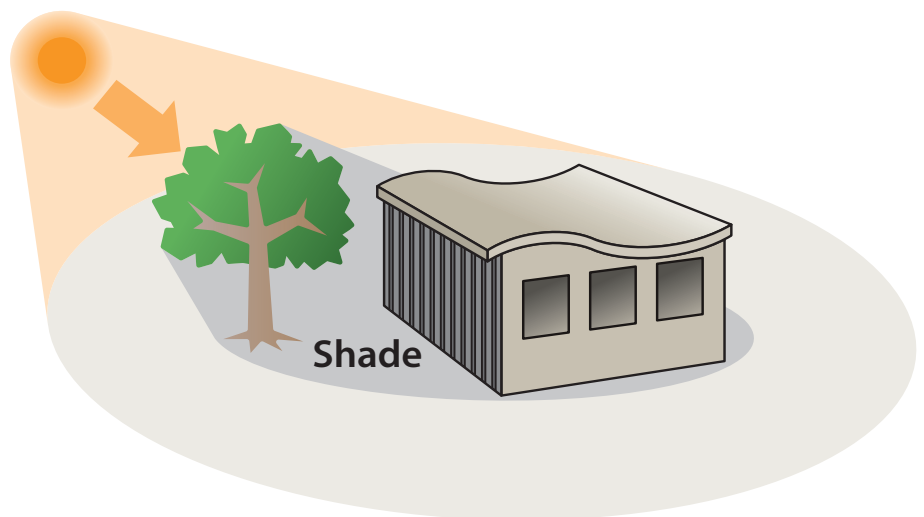

2.2 Colour selection and influence on performance

Colorcoat Renew SC® utilises Tata Steel’s high performance Colorcoat Prisma® pre-finished steel for the solar collector.

The collector colour and the pre-finished steel type are critical for determining solar thermal absorption rates and collector system efficiencies. Colorcoat Prisma® provides superior solar absorption characteristics and durability and the pre-finished steel durability and corrosion resistance are key attributes to achieve maximum collector efficiency and longevity. Tata Steel has also developed metallic and matt colours that deliver good solar efficiencies.

Colorcoat Prisma® combines a versatile palette of contemporary colours with durability and inherent flexibility. This results in a modern and durable building that will retain its appearance throughout the life of the collector.

For Colorcoat Renew SC® applications it is recommended to select colours with a high or preferably a very high solar thermal performance rating, so dark colours from the Colorcoat Prisma® range are recommended. However the ultimate choice may be guided by the aesthetic statement the building designer wishes to make and whether the solar collector is intended to blend in with the surrounding wall elevation or to be highlighted as a feature.

Figure 2. Solar thermal performance of Colorcoat Prisma®

Colorcoat Prisma®	Solarthermal Performance	Colorcoat Prisma®	Solarthermal Performance
Black	Very High	Orion	Moderate
Kronos		Coprium Matt	
Anthracite	High	Ephyra	
Anthracite Matt		Aquarius	
Chocolate Brown		Silver Metallic	
Clover		Athena	
Atlantis		Oyster	
Slate Grey		Sirius	
Helios		Hamlet	
Oxide Red	Good	Cream	
Alaska Grey		White	
Zeus			
Grey Aluminium			
Pegasus			
Denim			
Terracotta Matt			

For further details on colours visit: www.colorcoat-online.com or ring the Colorcoat Connection® helpline on +44(0)1244 892434



Metal hand samples are available for all colours. For a truer representation on colour and effect, please obtain metal hand samples from the Colorcoat Connection® helpline or visit www.colorcoat-online/samples

2.2.1 Guarantee Colorcoat Renew SC®

The corrosion resistance and colour stability of the Colorcoat Prisma® collector is guaranteed by Tata Steel for up to 25 years*, ensuring that optimum solar absorption efficiency is maintained for the lifetime of the solar collector. Tata Steel nevertheless recommends an annual inspection of the collector to ensure

that any accumulation of dirt is avoided. A suitable wash down of the surface would be the recommended maintenance requirement in such cases.

* Please contact your supply chain partner to confirm the exact guarantee available for your project location.

Colorcoat Prisma® Warranty Statement

This is a two page document

Warranty number and date	
Customer	
Project	
Coil Numbers	
Product	Colorcoat Prisma®
Application	Colorcoat Renew SC® Active Solar Air Heating system
Duration	25 years – Inland Zone 1
Signed	Dr Peter D. Barker Product Development Manager

The Colorcoat Prisma® pre-finished steel will resist the effects of the external environment design conditions and shall be satisfactory for use as a cladding fabric, providing weather protection for the said period of time.

Tata Steel will support the performance of Colorcoat Prisma® pre-finished steel, profiled by the beneficiary for the duration as indicated above. The warranty is in accordance with the following criteria, terms and conditions.

3. Collector design and sizing

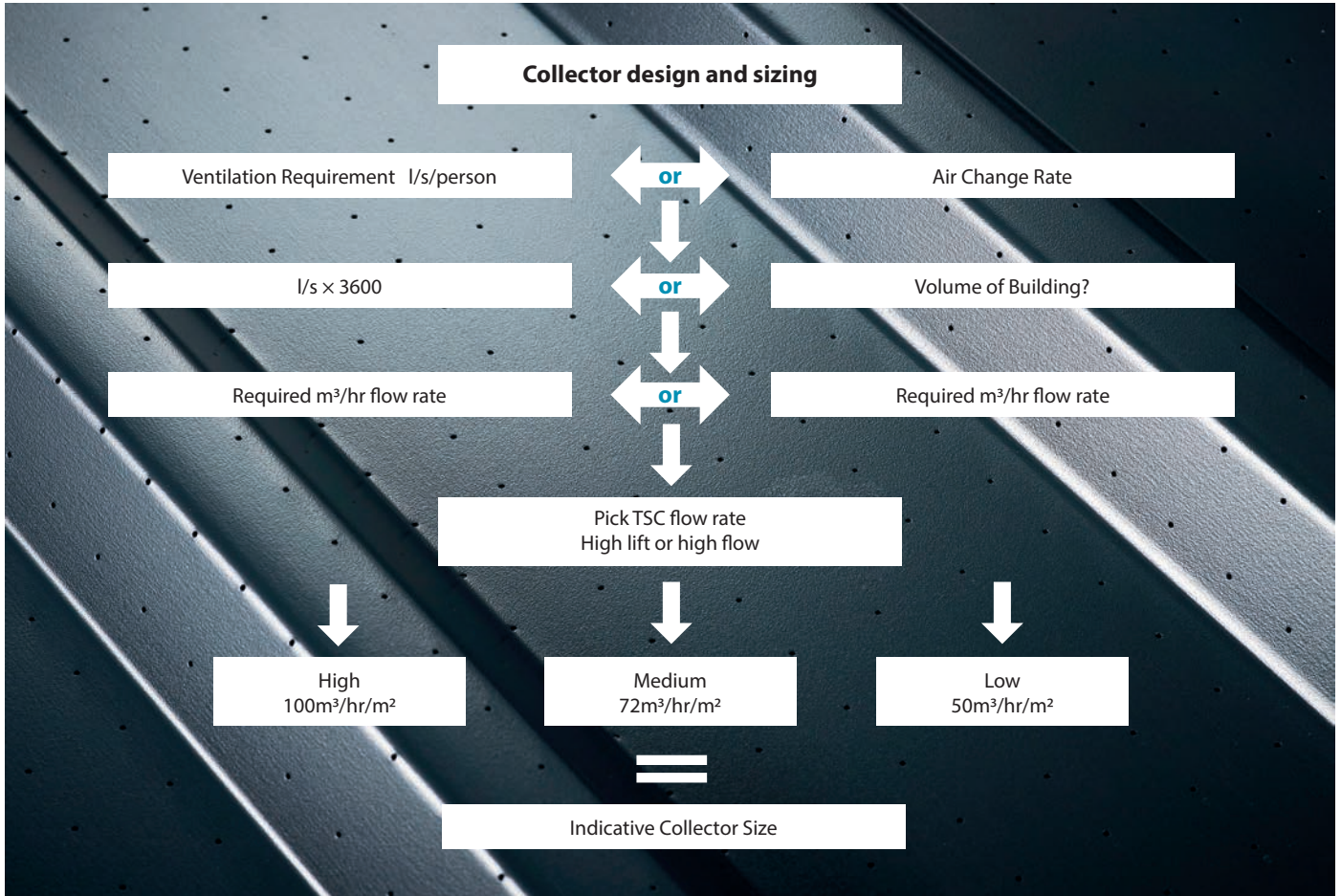

3.1 Building geometry, occupancy and function

To determine the most efficient size of collector for an individual building the key inputs for consideration are:

- Building geometry, aspect and location.
- The heat demand of the building.
- The building temperature set point.
- The level of ventilation (m^3/s) or air changes per hour required.
- The building size and geometry are the starting points for a successful Colorcoat Renew SC® collector design and installation. The dimensions of the internal building space, including roof space, must be determined. These, together with an understanding of the function of the building, user occupancy and overall heat balance influence the building ventilation and air change requirements which is needed to calculate the necessary airflow through the collector.

3.2 Solar collector sizing - description

3.2.1 Choose the wall for installation of Colorcoat Renew SC®

As described earlier in this guide, a south facing wall is most suitable for installation, but the elevation also needs to be sufficiently close to the space to be heated to allow the shortest distance for transfer of the solar pre heated air to the main air handling unit fan.

Consider also the position and size of any window and door openings or obstructions such as porches, fire escapes or rainwater downpipes, which will reduce the potential area for installation in practice. It may be possible to construct a Colorcoat Renew SC® system around openings but sizing and detailing of the solar collector will need to ensure unrestricted airflow movement through the plenum to the inlet.

3.2.2 Determine the volume of the building space to be heated

Quite simply, calculate the gross internal dimensions of the space to be heated (width x length x height).

3.2.3 Determine the volume of air required by the building ventilation system

Colorcoat Renew SC® can accommodate a wide range of ventilation rates. While the absolute amount of energy delivered will be determined by the level of solar irradiance on

the absorber plate, a trade-off can be made between the temperature rise achieved and the volume of air to be delivered.

Figure 3 below shows the relationship between airflow through the collector, and power output. In simple terms, the higher the airflow through the collector, the lower the temperature increase over ambient.

The required number of building space ventilation air changes per hour will determine the volume of air per hour which needs to be delivered through the collector.

3.2.4 Determine the optimum balance of heating and ventilation requirement

For approximate sizing of the Colorcoat Renew SC® solar collector, the next step is to determine the optimum flow rate through the collector dependent on the desired balance of temperature rise and fresh ventilation air volume delivery. Aim to heat as much fresh air as is possible for the required conditions. The relationship between solar radiation, air temperature rise and flow rate achievable with Colorcoat Renew SC® can be seen in Figure 4 below.

Read off the typical temperature rise which can be delivered by Colorcoat Renew SC® at the typical range of solar radiation levels to be expected at the building location over the average heating season and select the nearest flow rate curve, or use the guidelines which follow:

Divide the volume of air per hour needed (m^3/hr) by the selected flow rate ($m^3/m^2/hr$) to determine the approximate size of solar collector required (m^2).

Figure 3. Colorcoat Renew SC®: Power output (W/m^2) vs airflow and solar irradiance. – No wind

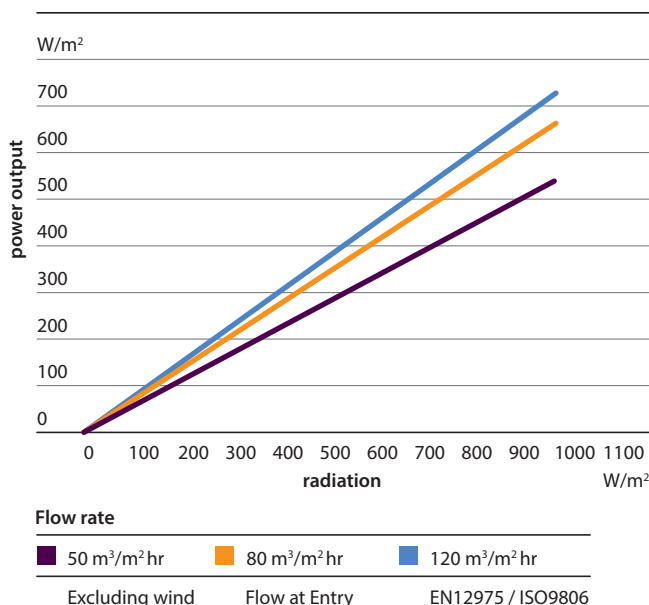
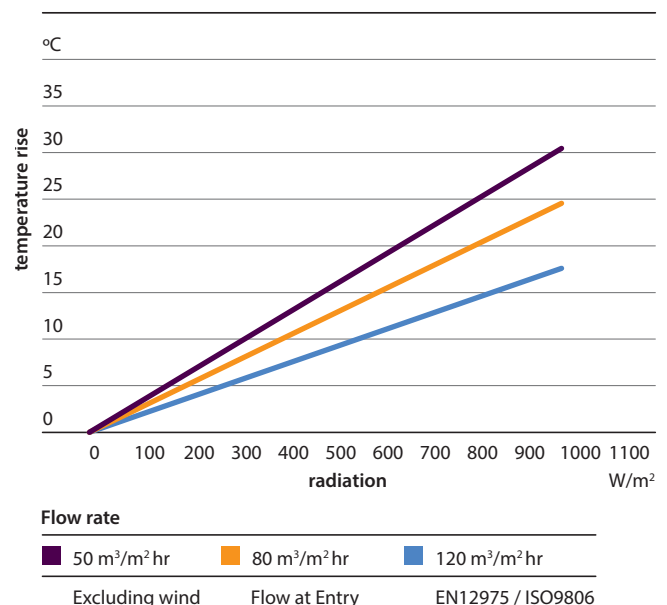

Figure 4. Colorcoat Renew SC®: Achievable temperature rise based on solar irradiance and airflow through the collector - No wind



Example Calculation

A workshop has an internal gross volume of 24,500m³ (50 x 70 x 7m). The southerly elevation has a surface area of 350m² (50 x 7m) with no restrictions due to openings or shading, so is in theory suitable for installation of Colorcoat Renew SC[®].

An air change of 0.5 of the air volume per hour is required for fresh air ventilation purposes.

24,500m³ x 0.5 = 12500m³/hr of air needs to be delivered through the collector.

The building has an internal temperature set point of 20°C which can be achieved by a solar collector airflow rate of approximately 80m³/m²/hr.

12,500m³/hr divided by 80m³/m²/hr. gives an approximate solar collector area of 156m² which can easily be accommodated on the available wall elevation.

3.2.5 Collector sizing guidelines

In northern hemisphere latitudes (47°- 55°), the insulation levels which can be expected over the course of an average heating season will range between 100 W/m² (overcast winter day) and 600 W/m² (bright, clear spring/ autumn day) ¹.

On sunny days, a high temperature rise delivered by Colorcoat Renew[®] will normally be more than 20°C above ambient. Typically Colorcoat Renew is sized to deliver a range of 15 to 25°C above ambient.

If a high temperature rise is required, or a low volume of ventilation air, design for an air volume through the collector of 45 to 55m³/hr per m² of collector area.

For most ventilation and make up air requirements an air volume of 70 to 80m³/hr per m² of collector area will provide a cost-effective solar collector size and good ventilation efficiencies.

If higher air volumes are needed for lower temperature pre heating of air, design for an airflow above 100m³/m²/hr. This will result in the highest solar conversion efficiencies.

Figure 5. The intensity of solar radiation (solar power) depending on the season measured in Watts per square metre (W/m²) ²

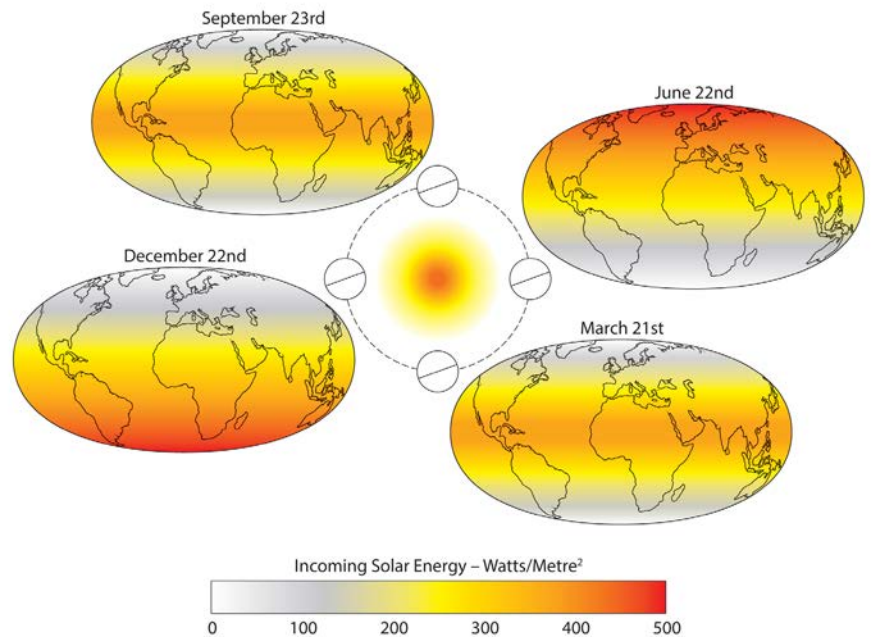

¹ Nielsen, R. 2005 'Solar Radiation'

² Sofia: Sharing of Free Intellectual Assets

3.3 CRAFT (Colorcoat Renew SC® Assessment and Feasibility Tool)

To simplify the decisions a designer needs to make when considering the aforementioned performance factors, Tata Steel has developed a bespoke project appraisal and feasibility tool which it uses to determine the potential performance of a Colorcoat Renew SC® system on an individual building. The software is

used to perform initial system feasibility assessments based on factors including building location, aspect, geometry and usage, historical weather data, system colour, heat demand and ventilation needs. The model is focused exclusively on Colorcoat Renew SC® solar air heating systems and the predicted performance

and savings available. The software models the building demand and energy balance according to the model described in EN ISO 13790:2008 and uses standard international location-specific weather databases as inputs to deliver project-specific feasibility assessments.

3.3.1 Feasibility

An example of a feasibility assessment carried out considering a typical building energy demand modelled against potential heat saving through the use of Colorcoat Renew SC® is shown in Figure 6 below.

Figure 6. Typical CRAFT feasibility calculation outputs

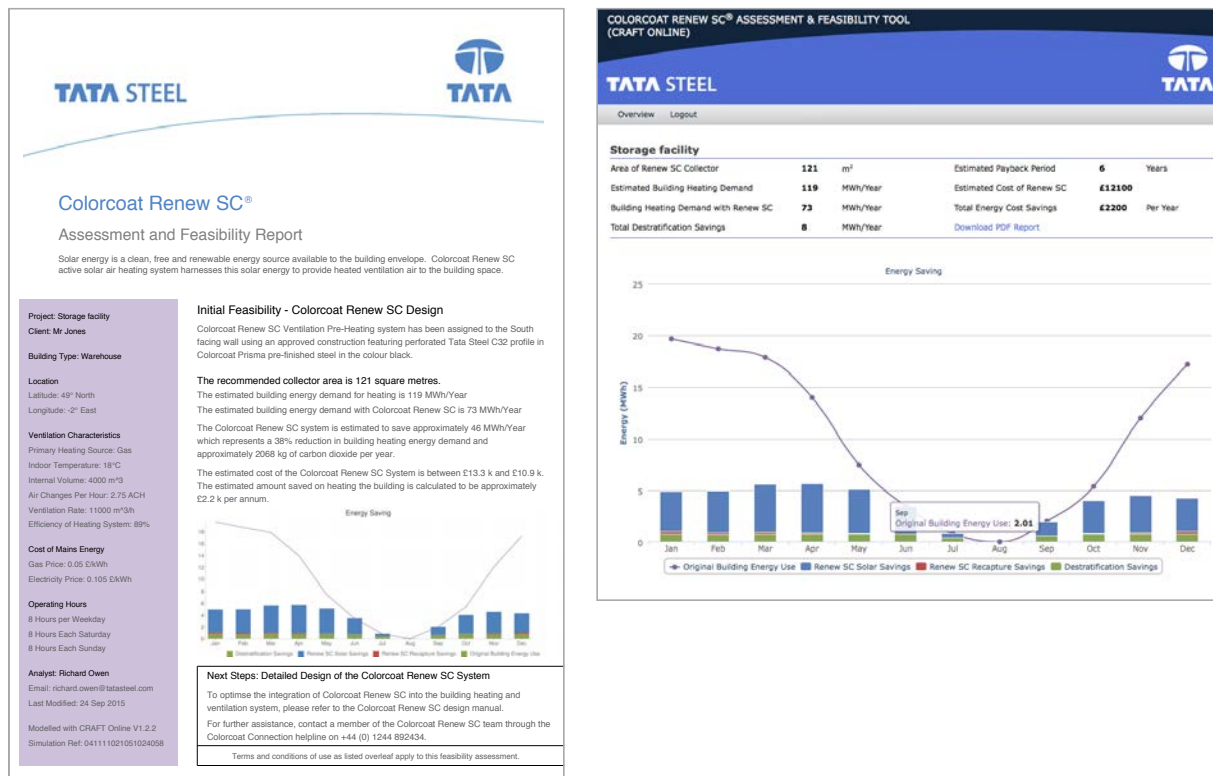

3.4 Other physical solar collector design considerations

3.4.1 Perforation diameter and pitch

Perforation size and pitch determine the porosity of the solar collector which in turn has an influence on the airflow which is drawn through the collector. Higher airflows through the Colorcoat Renew SC® system will deliver a lower temperature uplift but are more efficient in terms of the overall energy delivered (kWh/m²) relative to the collector size. Conversely, low airflows deliver greater temperature uplift but are less efficient.

Many permutations of perforation diameter, perforation pitch and 'open' area are theoretically possible. The balance of these factors has an impact on overall system performance. Tata Steel has standardised the combination of perforation diameter and pitch it offers in order to:

- Maximise the heat transfer capability and optimise Colorcoat Renew SC® system efficiency to suit most requirements.
- Resist rainwater ingress into the plenum cavity.
- Inhibit blockage of the airflow into the plenum.

Figure 7. Illustration of perforation and pitch density



3.4.2 Profile options

Various profile shapes and depths are available from Tata Steel supply chain partners. These allow a choice of design for integration of the Colorcoat Renew SC® system within the building envelope, but will also present a variety of solar absorber plate surface areas to the sun, which will influence the overall area of the boundary solar heat layer. Profile design will also have an impact on heated air movement within the plenum. Contact Tata Steel or its supply chain partners for further advice.

Figure 8. Typical profile options

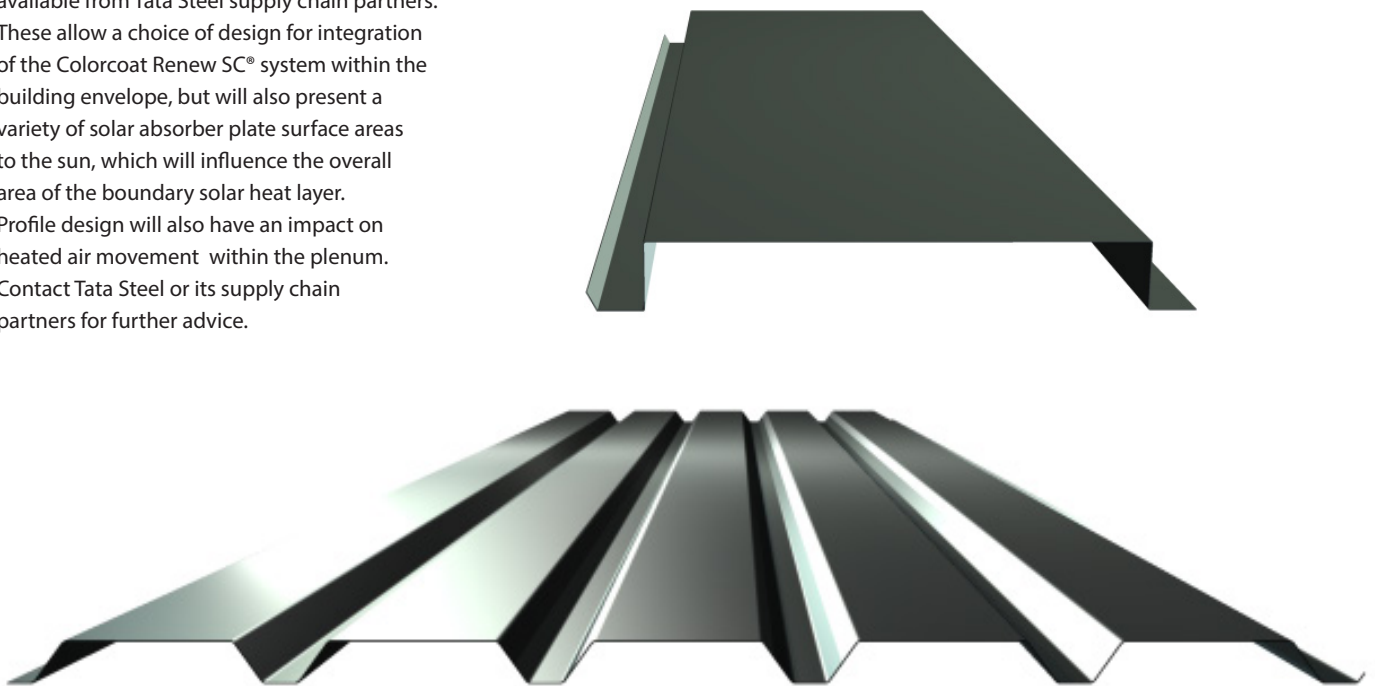

3.4.3 Cavity (plenum)

The depth of the cavity (plenum) between the absorber plate and the supporting wall together with the collector size will influence pressure drop and therefore airflow through the collector. In order to maximise collector airflow uniformity and to maintain a recommended 3m/s vertical

velocity through the cavity, an optimum plenum depth of 170mm is recommended. At a medium airflow rate (eg, 80m³/m²/h) this will result in a good balance between efficiency and temperature uplift, suitable for most applications.

Figure 9. Typical profile options

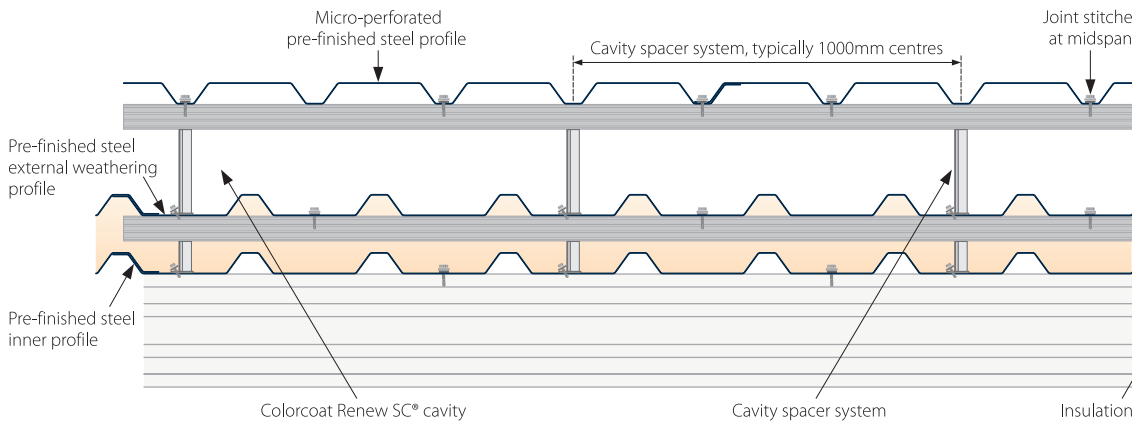

3.4.4 Solar collector integration

Colorcoat Renew SC® solar collectors should be designed with a maximum width of 30m per outlet or a maximum overall area of 300m². Tall and narrow collectors are however generally more efficient and are recommended wherever possible.

Where collectors are sized with a width in excess of 30m the number of outlets will be increased so as not to exceed the recommended maximum 30m collector width.

For example a collector of 800m² would typically be served by three transition ducts which would be serviced by three fans.

The collector outlet (inlet into the building) should be placed as centrally as possible to the width and at the upper end of the collector to facilitate high level distribution of warm air into the building.

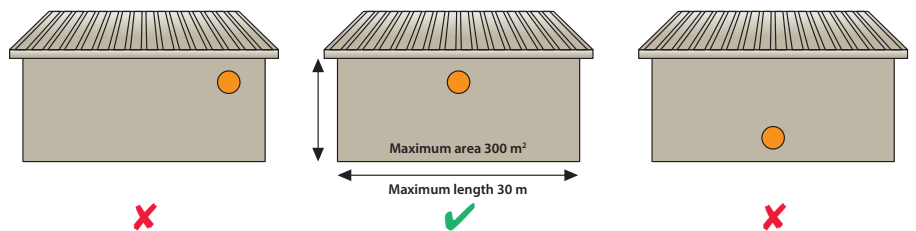

4. Construction

4.1 Requirements and regulations

Colorcoat Renew SC® should be installed in accordance with national Building Regulations and local planning requirements. The installation of a Colorcoat Renew SC® solar collector can be regarded as being similar to that of a metal building façade system: the solar collector is installed onto an exterior wall elevation using conventional metal cladding components and accessories.

For a practical and cost-effective installation the Colorcoat Renew SC® solar collector should be installed as part of the overall building envelope construction process. Installation techniques, components, and processes are those commonly used within the cladding industry thus avoiding the need for any specific training or equipment. Colorcoat Renew SC® is designed to be integrated with a range of engineered building envelope and cladding systems.

4.2 Collector components

The solar collector and flashings are manufactured from Colorcoat Prisma® pre-finished steel with a typical nominal gauge of 0.7mm.

The micro-perforated collector sheet is installed using an industry standard proprietary bar and bracket type system to create a cavity with the supporting wall. A typical cavity depth is 170mm, which is easily achieved by readily available market sizes of bar and bracket system.

The supporting wall for the collector should have a stable construction and be able to support the loads applied by and through the operation of the Colorcoat Renew SC® system, when the latter is fixed through to secondary steel work. Colorcoat Renew SC® has been tested to withstand pressures in excess of 2500Pa, however all imposed loads (including wind) should be confirmed by a qualified structural engineer.

Top and side closure flashings must be detailed in such a manner that rain water cannot enter the collector cavity. A drip flashing should be incorporated in base

flashing details and although condensation or accumulation of water is extremely unlikely within the cavity, weep holes should be incorporated into the bottom closure flashings at 1 metre centres as a precautionary measure. Closed cell profile fillers and EPDM or closed cell sealants should be incorporated to ensure that solar heated air only is drawn through the micro-perforated collector. The wall opening for the cavity outlet should be centrally positioned at the top of the collector, space to accommodate installation of a transition duct. The size of the opening will be determined by the building ventilation requirements.

4.3 Typical construction details

Detailed construction details for both collector and mounting system are available through Tata Steel supply chain partners.

(the following diagrams are for illustrative purposes only)

Vertical construction general arrangement details; horizontal section

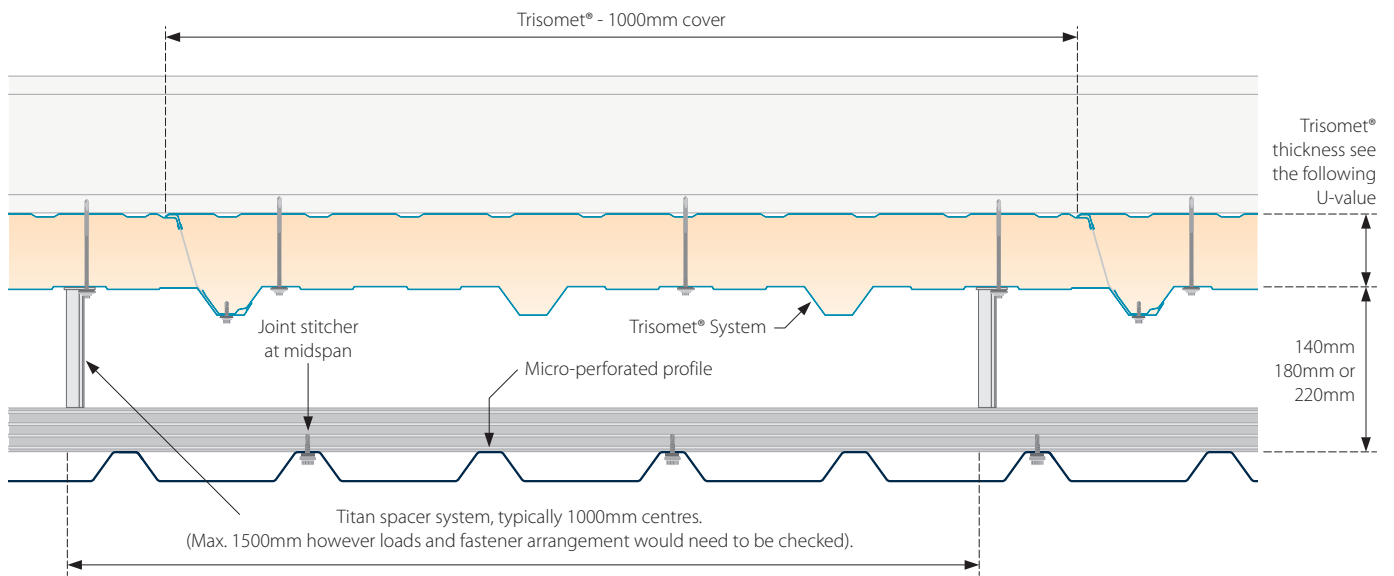

Vertical construction general arrangement details; vertical section

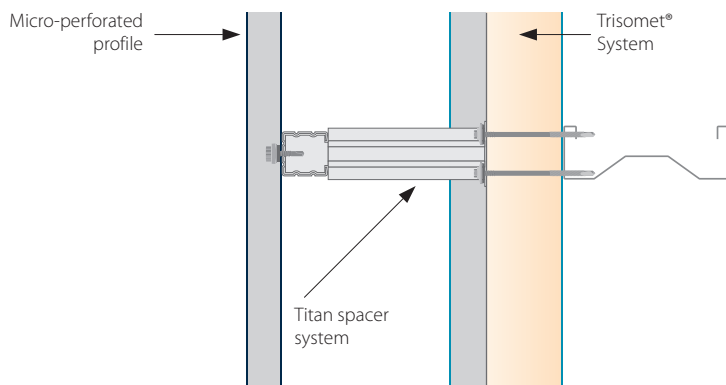

Verge detail

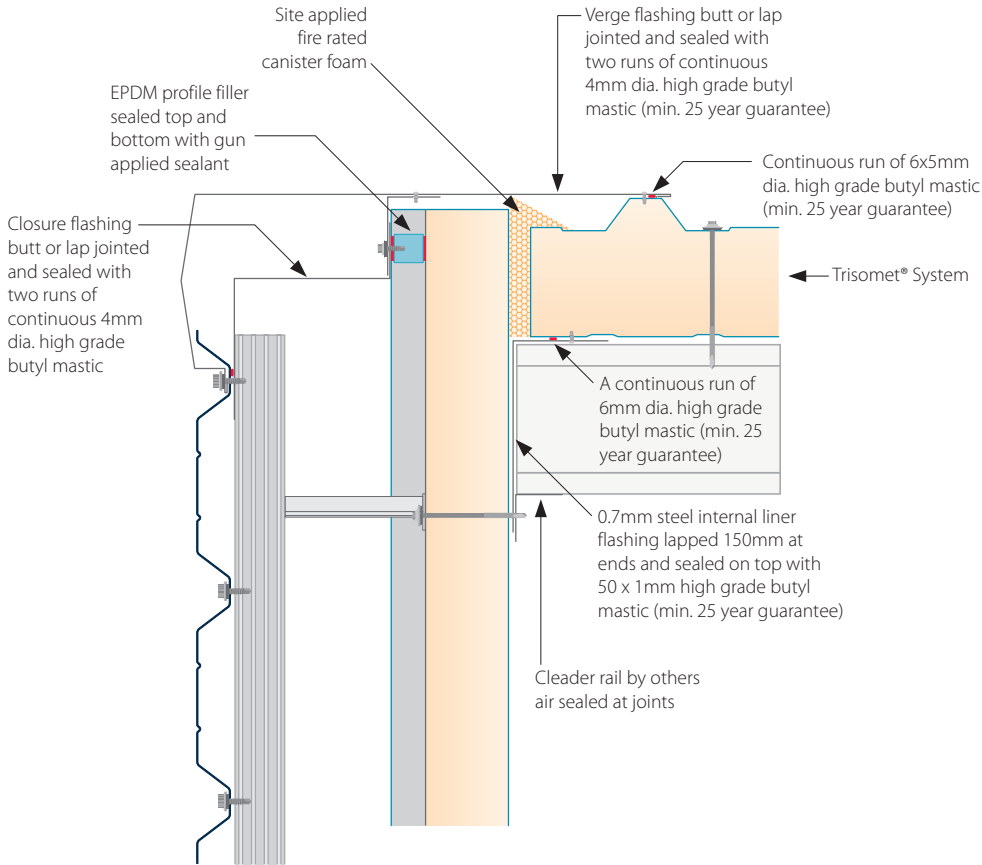

Base detail

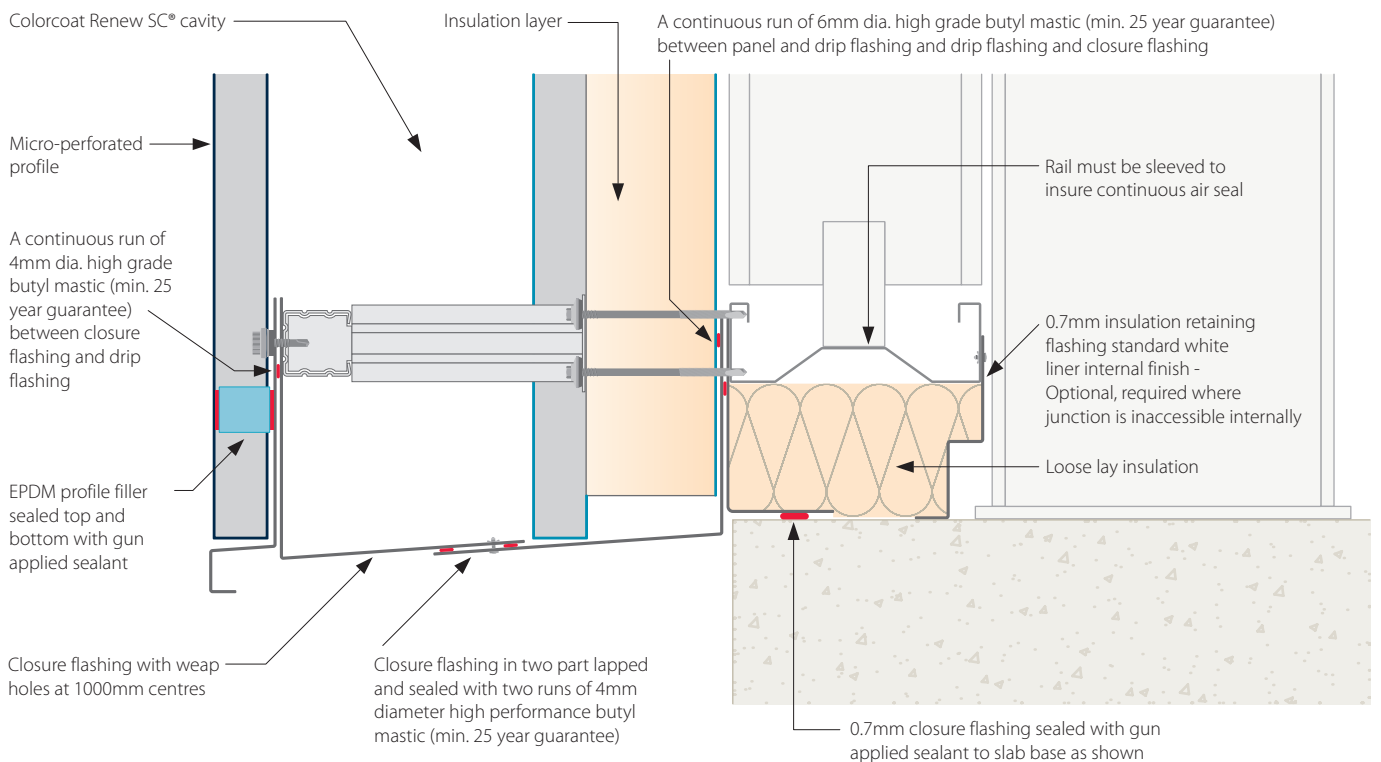

Corner detail

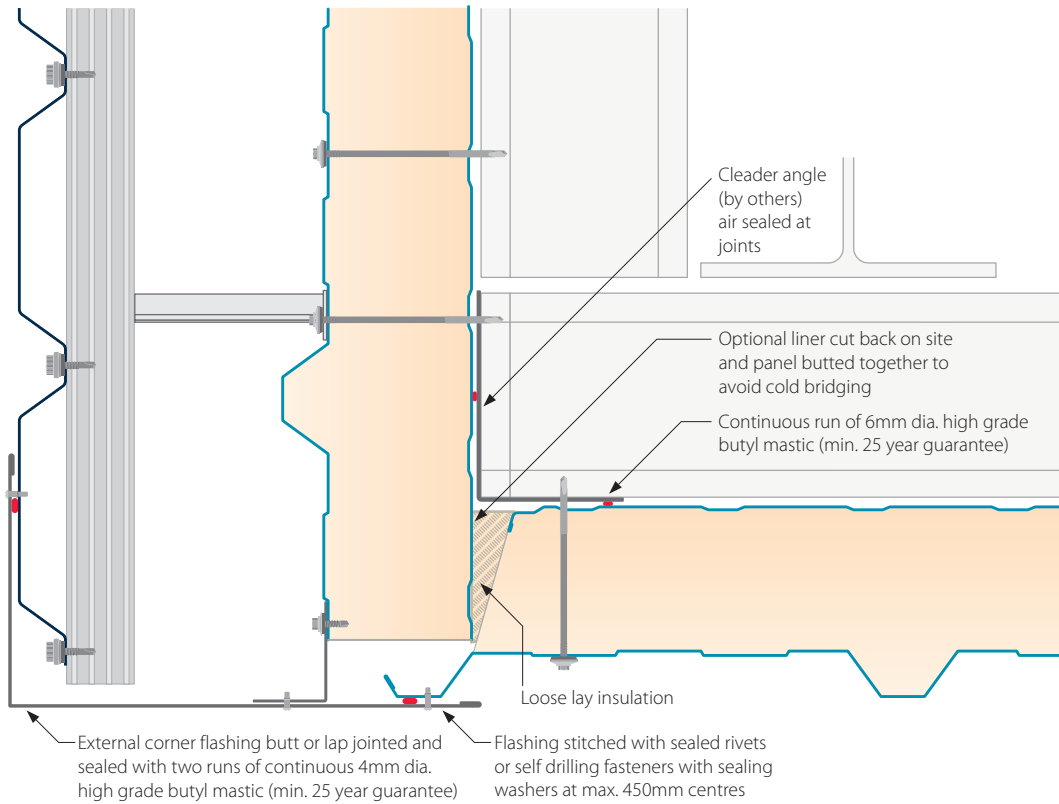

Vent detail

Parapet flashing max. unsupported length of 200mm butt or lap jointed and sealed with two runs of continuous 4mm dia. high grade butyl mastic (min. 25 year guarantee)

Closure flashing butt or lap jointed and sealed with two runs of continuous 4mm dia. high grade butyl mastic

EPDM profile filler sealed top and bottom with gun applied sealant

200mm-1000mm Typical

Secondary steelwork trim around opening, (by others)

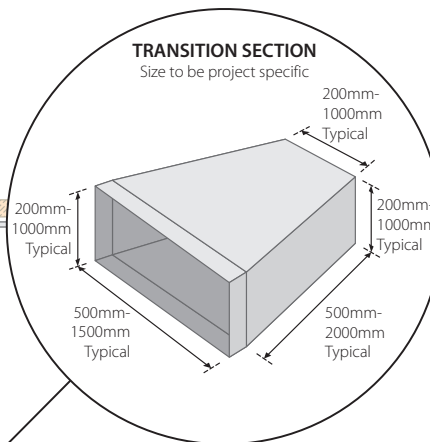

Notes:-
 The details within the Section 4.3 are recommendations and have been designed to give practical solutions to minimise thermal bridging and air loss at junctions, air intake into the cavity and any water ingress into the Colorcoat Renew SC®.

Case study

Swalec Smart Energy Centre, Treforest

Tata Steel's Colorcoat Renew SC® active solar air heating system was chosen for installation at the Swalec Smart Energy Centre in Treforest, South Wales. The Colorcoat Renew SC® uses freely available, renewable solar radiation, captured on the building elevation to provide controllable, fresh, heated ventilation air to maximise occupant comfort. This sustainable system lowers the building's carbon footprint.

Client: SSE

Architect: Glanville Consultants Ltd

Principal contractor: Interserve

M&E contractor: Southern Electric Contracting

M&E design consultants: Vector Design Ltd

Installation contractor: Massey Cladding

Tata Steel products: Colorcoat Renew SC®

solar air heating system with micro-perforated Trisobuild® C32 profile solar collector, manufactured from Colorcoat Prisma® pre-finished steel in Anthracite supplied in a micro-perforated Trisobuild C32® profile solar collector.



4.4 Fasteners

The Colorcoat Renew SC® solar collector is mounted onto an exterior wall of a building using industry standard fastening screws for thin gauge steel building elements, and all in accordance with national and local building regulations and recognised industry best practice.

As the collector is to be wall mounted, snow loads do not need to be accommodated. However the impact of wind loads must be considered in accordance with conditions for a conventional profiled steel building façade.

4.5 Maintenance recommendations

As is the case for all exterior building system components manufactured from Tata Steel Colorcoat® pre-finished steel, good inspection and maintenance practice will repay the careful building owner with the best possible

performance of the Colorcoat Renew SC® system in terms of its appearance, durability and lifespan. Please consult Tata Steel document 'Inspection and Maintenance Guidance for pre-finished steel'.

5. Mechanical and electrical design considerations

5.1 Building heating and ventilation requirements

The volume of mechanical ventilation air to be heated is critical to the sizing of the required Colorcoat Renew SC® solar collector. The air change requirement and the building's internal temperature set point should be determined by the project design team based on building use, occupancy, internal processes which generate heat, manufacturing activities or other key activities.

Colorcoat Renew SC® has been designed to function as a pre heater for integration with the HVAC system of a building.

The collector size and airflow through the collector will both determine the total energy

a collector will supply to the building and also the temperature gain of the supplied air. The solar collector will be installed by a cladding contractor who should also make the penetration through the supporting wall for the inlet into the building. The inlet transition duct should be sized according to the volume of air which needs to be delivered through the duct subject to a maximum horizontal velocity at the top of the duct of 5m/s. Airflow variations will impact upon the pressure drop through the collector. Consideration of these factors will ensure the correct choices are taken on associated matters such as fan type, duct size, opening or closing the air supply and fan control.

5.1.1 Intake air quality

As the Colorcoat Renew SC® system delivers external air directly or via a HVAC system into a building or room space, there is a direct impact on overall occupant comfort. It is therefore essential that the air is not contaminated or polluted. Consideration should be given to position the Colorcoat

Renew SC® collector away from features which could impact on the intake air quality such as air conditioning or ventilation system exhaust outlets, lorry parks, paint shops, effluent plants or fixed plant and machinery. Filters should be integrated in the air handling unit in accordance with prescribed standards.

5.2 Relationship between airflow, temperature increase and efficiency

5.2.1 Temperature rise

Typically Colorcoat Renew SC® is used in circumstances where mechanical ventilation air volume is required at a prescribed airflow rate. However the temperature rise over ambient delivered by Colorcoat Renew SC® is influenced by the air mass flow rate. Colorcoat Renew® will operate satisfactorily at airflows between 50 and 120m³/m²/hr.

Solar radiation heats the boundary layer on the external face of the collector and this heated air is drawn through the collector plate. The higher the velocity of the air, drawn through the collector, the less time is available for the heat transfer. Therefore the temperature rise is greater at lower velocities.

However if the velocity through the collector is too low the efficiency of the system is impacted negatively by wind effects.

In order to maximise collector airflow uniformity and to maintain efficiency, a 3m/s vertical velocity through the collector cavity is recommended. A plenum depth of 170mm and an airflow rate of 72m³/m²/hr through the collector is ideal for most applications. This will result in a combination of good efficiency and reasonable temperature uplift.

The relationship between airflow, and the efficiency of Colorcoat Renew SC® is shown below:

Figure 10. Colorcoat Renew SC® Efficiency relative to airflow through the collector

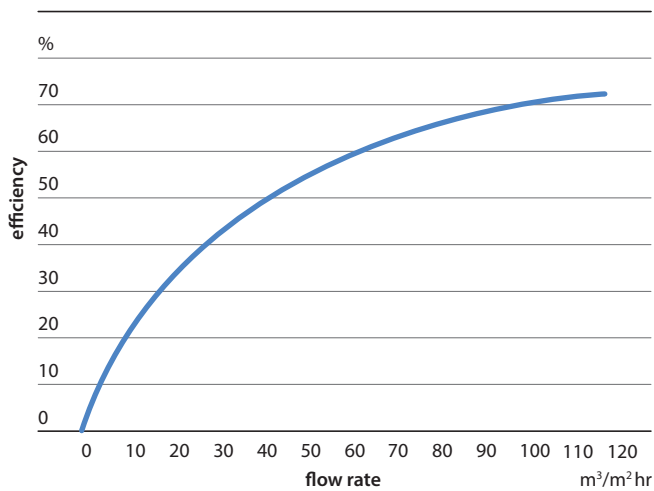

5.2.2 Wind considerations

For optimum airflow, the Colorcoat Renew SC® system should be designed to accommodate a minimum surface face velocity (SFV) of air at the micro-perforated absorber plate of 0.020m/s.

A surface face velocity of less than 0.020m/s can result in wind disturbing the thermal boundary layer, potentially causing back flow and thus reducing the collector efficiency.



5.2.3 Transition duct sizing

Solar heated air is transferred from the collector plenum via the transition duct into the building. Air speeds within the transition duct should allow the flow to be laminar and

to reduce the risk of noise within the duct system. Building requirements on ventilation rates and need for air volume determine therefore the surface and diameter of the inlet duct.

5.2.4 Pressure Drop

The total pressure drop through the perforated solar collector absorber plate, plenum and transition duct can be expected to be between 20 -100Pa at normal

operational flow rates. See Figure 10. In the duct a pressure drop of approximately 3Pa/m is expected at an airspeed of 3m/s.

Figure 11. Measured pressure drop through Colorcoat Renew®

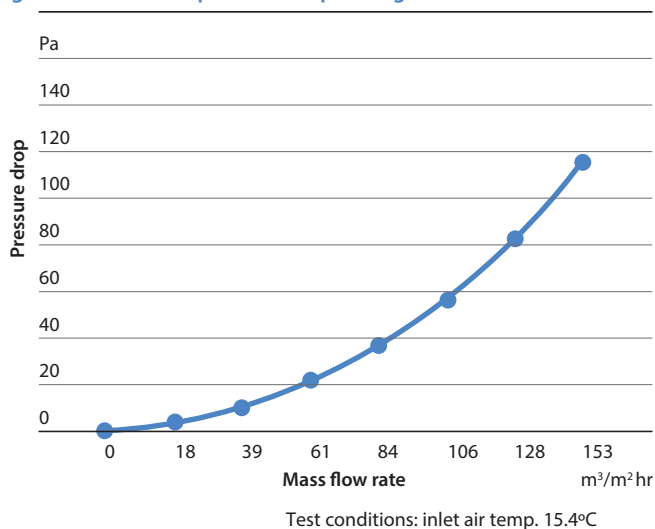

5.3 Operating modes

As a solar air heating system, the perforated Colorcoat Renew SC® solar collector plate receives 100% of the irradiance landing on the absorber surface. Colorcoat Renew SC® is designed to supply external fresh air above ambient temperature to reduce the conventional heat required to achieve the building space temperature.

When conditions dictate the Colorcoat Renew SC® collector can be bypassed by closing damper 4 and fully opening damper 5 to allow ambient air to be drawn into the distribution system via the summer bypass inlet and associated duct work.

The following operating modes can be accommodated:

- Colorcoat Renew SC® solar collector air temperature is sufficient to provide building set point temperature. Damper 4 fully open, Damper 5 fully closed.

- Colorcoat Renew SC® solar air temperature is above ambient but is not sufficient to provide full set point temperature. Damper 4 fully open to pull all available solar heated air through the collector but boosted by the conventional heating system (or additional option to mix with re-circulated internal air). Damper 5 fully closed.
- Solar heated air higher than required temperature set point. If the solar air temperature is within the allowable comfort band for building occupancy, then either
 - a. allow supply of 'excess' solar heated air to charge the thermal mass of the building fabric to act as an energy store to discharge and regulate the temperature as required, or
 - b. mix solar heated air with cooler air drawn through the bypass duct. Damper 4 and 5 will be partially open and modulated to regulate the required airflow and temperature.

- In summer, fully close damper 4. Damper 5 should be open to supply ambient fresh air as required. Excess heat can also be vented from the Colorcoat Renew SC® cavity by incorporation of ventilation dampers as required.

5.4 System control and metering

Operational and system control advice is available from Tata Steel to assist designers on sensor placement and damper control for the integration of a Colorcoat Renew SC® system to function as a pre heater to a ventilated warm-air system.

Tata Steel can also provide a slave control system to operate in conjunction with any building management system employed to optimise the delivery of renewable heat from the Colorcoat Renew SC® installation.

For further help and support please contact the Colorcoat Renew SC® Integrated Sales Team on T: +44 (0) 1244 892336 or 892331.

Figure 12. Incorporation of an ambient air bypass duct and dampers

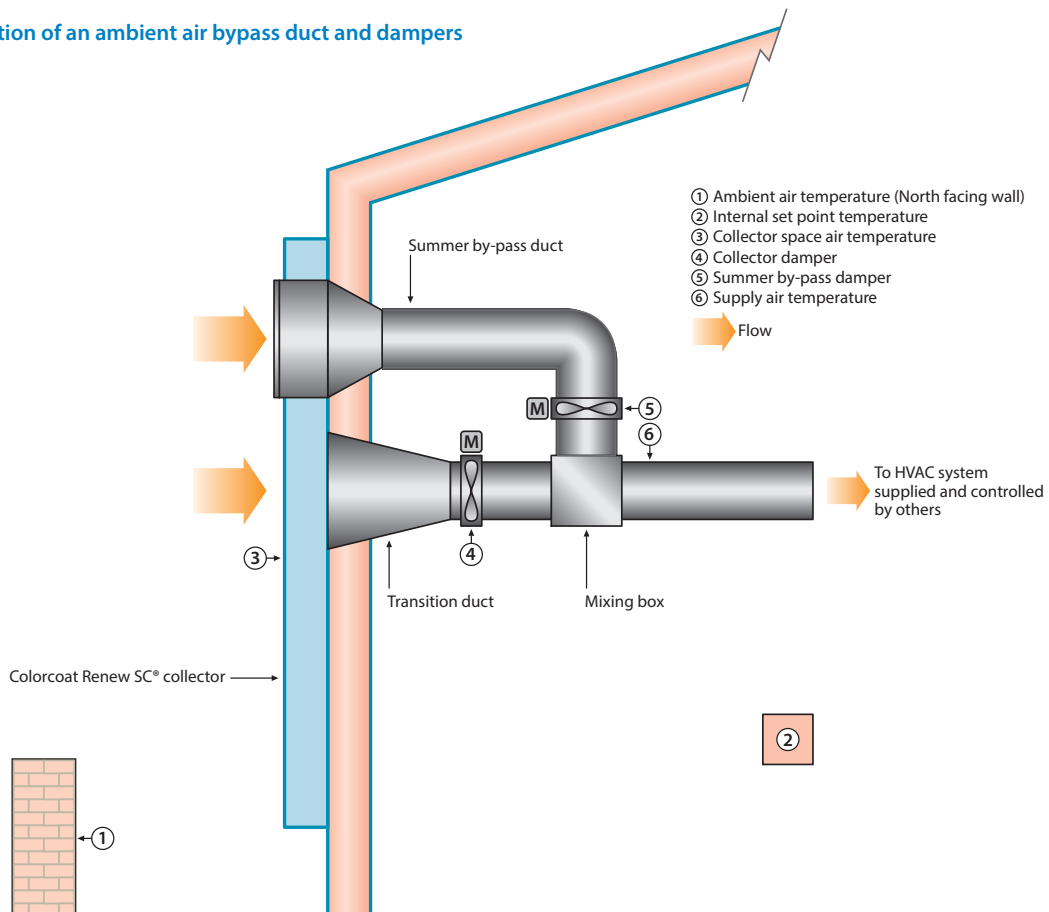

6. Reference projects

Colorcoat Renew SC® has been installed on a number of projects in UK and mainland Europe. Projects include:

Project Name	Image No.	Location	Area (m ²)	Year Completed
Sustainable Building Envelope Centre, Shotton	1	Deeside, Flintshire, UK	157	2011
Visitor Centre, Tata Steel, Shotton Works	2	Deeside, Flintshire, UK	25	2013
Visitor Centre, Tata Steel, Scunthorpe Works,	3	Scunthorpe, Lincs., UK	25	2013
Deeside Leisure Centre	4	Deeside, Flintshire, UK	216	2011
Jaguar Land Rover, Deck 92	5	Solihull, W. Midlands, UK	585	2012
Jaguar Land Rover, The Engine Plant	6	Wolverhampton, UK	108	2014
Baglan Bay School	7	Baglan, Swansea	284	2015
Swalec Smart Energy Centre	8	Treforest, Rhondda Cynon Taf	148	2012

Project details are available from Tata Steel upon request



7. Colorcoat Renew SC® product characteristics

Solar Absorber	
Material	Colorcoat Prisma® pre-finished steel to EN10169:2010+A1:2012, micro-perforated after coating.
Organic coating thickness	50µ nominal, to EN13523-1
Base material	Galvalloy® Hot- dipped zinc aluminium alloy (ZA) to EN10346
Gauge	0.675mm nominal, tolerances to EN 10346
Dimensions	Solar absorber plate to required building dimensions. Typically site-assembled from roll-formed trapezoidal steel profiled sheets to EN 508-1 of approximately 1000mm cover width, sheet length to client requirements.
Typical weight	Absorber plate 7 Kg/m ²
Plenum construction	Solar absorber plate mounted on supporting wall using approved galvanized steel spacer bar construction, to create air cavity of typically 170-180mm depth. Side and end closures made from Colorcoat Prisma®. Flashings material specification as above.

Solar Collector Characteristics	
Type	Open to ambient unglazed solar air heater to ISO 9806:2013/EN 12975-1: 2006 + A1:2010
Climate reference conditions	Climate Class B, Sunny, to ISO 9806:2013. §11, Table 4
Nominal airflow	0,024kg(air)/m ² (collector area)/s
Maximum airflow	0.06kg/m ² /s (approx 180m ³ /m ² /hr), tested to ISO 9806:2013
Perforation area	0.4% open area
Stagnation temperature	80°C maximum, <i>measured at absorber in accordance with ISO 9806:2013</i>
Starting temperature	80°C maximum, <i>measured at air outlet in accordance with ISO 9806:2013</i>
Maximum continuous operating temperature	70°C <i>measured in accordance with ISO 9806:2013</i>
Mechanical loads	Solar collector to be constructed in accordance with local wind load requirements. <i>Collector tested to 2500Pa max in accordance with ISO 9806:2013</i>

Performance Characteristics									
Peak power output (W)	720 W/m ² of absorber plate area- <i>Instantaneous peak power measured in accordance with ISO 9806:2013 – Irradiance 1000W/m² - Zero wind conditions</i>								
Efficiency	Up to 74%, <i>Instantaneous efficiency measured in accordance with ISO 9806:2013 – Irradiance 908W/m². Zero wind conditions</i>								
Pressure drop through collector	<table border="1"> <thead> <tr> <th>Airflow (m³/m²/hr)</th> <th>Pressure drop (Pa)</th> </tr> </thead> <tbody> <tr> <td>48</td> <td>16</td> </tr> <tr> <td>72</td> <td>31</td> </tr> <tr> <td>120</td> <td>86</td> </tr> </tbody> </table> <i>Measured in accordance with ISO 9806:2013</i>	Airflow (m ³ /m ² /hr)	Pressure drop (Pa)	48	16	72	31	120	86
Airflow (m ³ /m ² /hr)	Pressure drop (Pa)								
48	16								
72	31								
120	86								



8. References/Bibliography

1. EN ISO 9806:2013 – Solar Energy- Solar thermal collectors- Test methods
2. EN12975-1:2006 +A1:2010 – Thermal solar systems and components – Solar collectors
3. Test report according to EN12975-1:2006+A1:2010/EN ISO 9806:2013 – KTB Nr.2014-25 – Fraunhofer-Insitut für Solare Energiesysteme ISE, 79110 Freiburg, Germany
4. Colorcoat Prisma® Technical Details brochure, Tata Steel. May 2013
5. Colorcoat® Technical Papers. <http://www.colorcoat-online.com/en>
6. EN ISO 13790:2008. Energy performance of buildings – Calculation of energy use for space heating and cooling
7. J. A. Duffie and W. A. Beckman, Solar Engineering for Thermal Processes, Fourth Edi. Wiley, 2013.
8. C. F. Kutscher, C. B. Christensen, and G. M. Barker, “Unglazed Transpired Solar Collectors : Heat Loss Theory,” vol. 115, no. AUGUST, 1993
9. R. Hall, X. Wang, R. Ogden, and L. Elghali, “Transpired solar collectors for ventilation air heating,” Proc. ICE - Energy, vol. 164, no. 3, pp. 101–110, Aug. 2011
10. C. Brown, E. Perisoglou, R. Hall, and V. Stevenson, “Transpired Solar Collector Installations in Wales and England,” Energy Procedia, vol. 48, pp. 18–27, 2014.
11. B. Sicre, P. Baumann, High-efficiency ventilation and heating systems by means of solar air collectors for industry building refurbishment, School of Engineering and Architecture, Lucerne University of Applied Sciences. International Journal of Low-Carbon Technologies Advance Access, March 2015
12. EN 14782:2006 Self supporting metal sheet for roofing, external cladding and internal lining. Product specification and requirements
13. EN 14509:2013 Self supporting double skin metal faced insulating panels.Factory made products. Specifications
14. UK Metal Cladding and Roofing Manufacturers Association (MCRMA), Technical Design Guides. Contact info@mcrma.co.uk
15. Engineered Panels in Construction (EPIC) guides. <http://www.epic.uk.com/>
16. Letter from Paula Abreu Marques ,EU Commission Directorate C1, Renewables and CCS policy, to Tata Steel. Ref ENER/C. 1/BK/gener.c.I (2013)3691521 11 Nov 2013. Conformation of renewable status of active solar air heaters

9. Additional services and contact points

A facility for designers to model the energy performance and contribution of Colorcoat Renew SC® integrated into a building heating and ventilation network is available in the leading dynamic thermal energy modelling software IES VE. The software facilitates

compliance of a building incorporating Colorcoat Renew SC® with UK Building Regulations and is fully compatible with the requirements of Building Information Modelling (BIM).Contact www.iesve.com for details

www.tatasteelconstruction.com

Trademarks of Tata Steel UK Limited

Colorcoat, Colorcoat Connection, Colorcoat Renew SC, Confidex, Platinum Plus, Colorcoat Prisma, Trimapanel and Trisomet are registered trademarks of Tata Steel UK Limited.

Care has been taken to ensure that the contents of this publication are accurate, but Tata Steel Europe Limited and its subsidiaries, (including Tata Steel UK Limited), do not accept responsibility or liability for errors or information that is found to be misleading. Suggestions for, or descriptions of, the end use or application of products or methods of working are for information only and Tata Steel Europe Limited and its subsidiaries accept no liability in respect thereof.

Before using products or services supplied or manufactured by Tata Steel Europe Limited and its subsidiaries, customers should satisfy themselves as to their suitability.

Copyright 2016 Tata Steel

Integrated Sales Team

Tata Steel
Building Envelope
Shotton Works
Deeside
CH5 2NH
T: +44 (0) 1244 892331/892336
Email: colorcoatrenew@tatasteel.com

For all other enquiries regarding
Colorcoat® pre-finished steel:

Tata Steel
Shotton Works
Deeside
Flintshire
CH5 2NH
United Kingdom
T: +44 (0) 1244 892345

Tata Steel UK Limited, is registered in England under number 2280000, with registered Office at 30 Millbank London SW1P 4WY.

Colorcoat Connection® helpline
T: +44 (0) 1244 892434
E: colorcoat.connection@tatasteel.com

Copyright 2016 Tata Steel
Language English TSBS02:PDF:ENG:0116